

# Dimensions

## 1 Indoor Unit

### 1.1 CS-PU24AKH

<Top View>

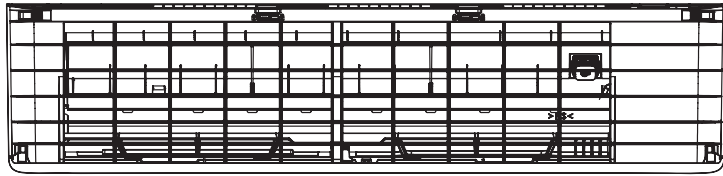

<Front View>

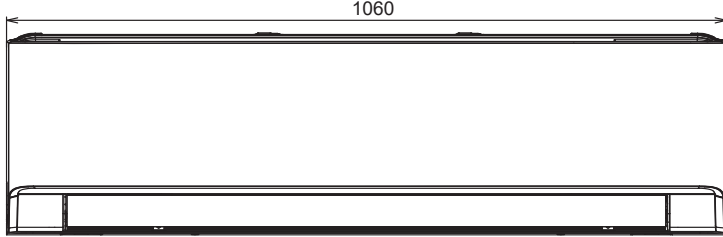

<Bottom View>

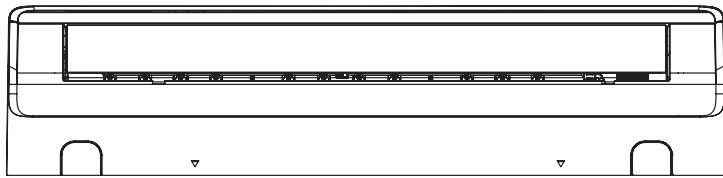

<Rear View>

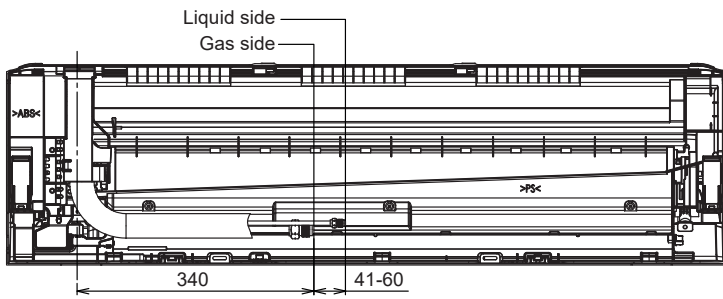

Relative position between the indoor and the installation plate <Front View>

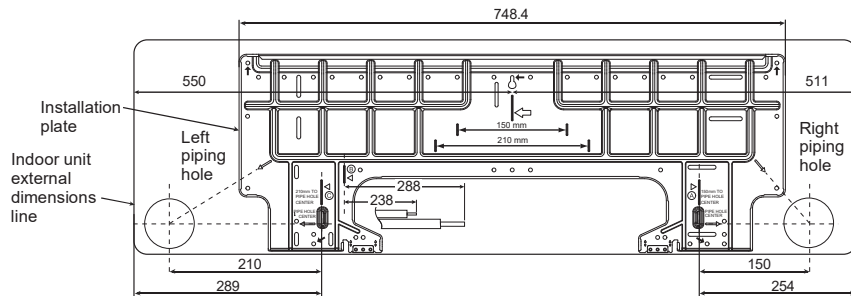

<Side View>

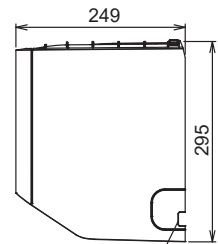

Right piping hole

<Remote Control>

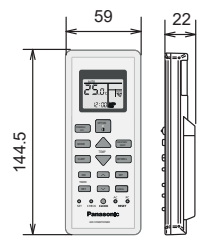

<Remote Control Holder>

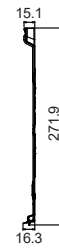
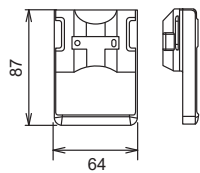

Unit : mm

## 2 Outdoor Unit

### 2.1 CU-RU24AKH

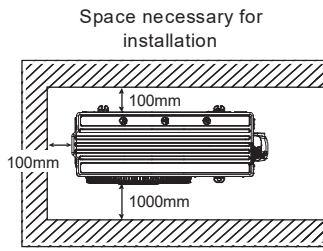

Anchor Bolt Pitch  
330 × 540

<Top View>

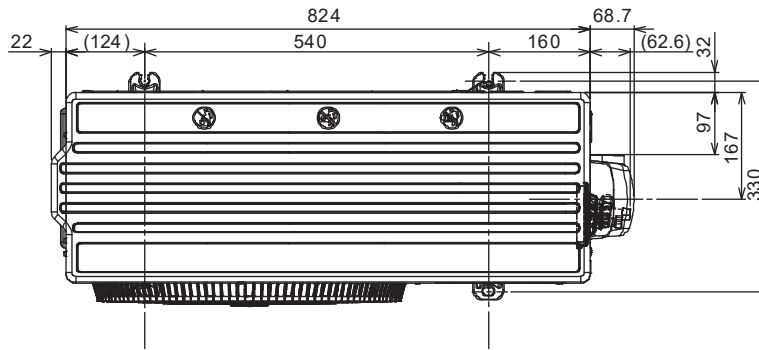

<Side View>

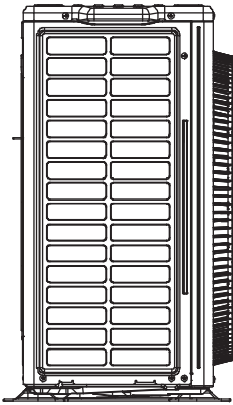

<Front View>

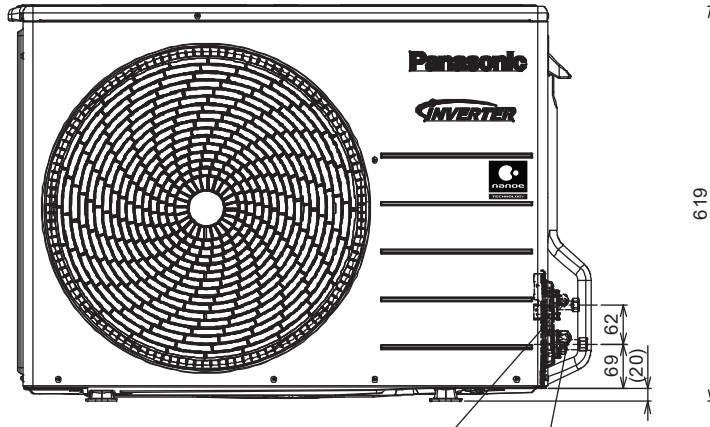

<Side View>

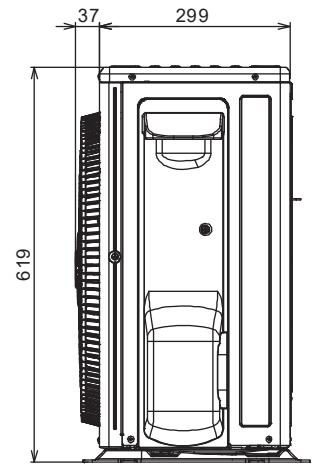

Unit : mm

3-way valve at Gas side  
(Low Pressure)

2-way valve at Liquid side  
(High Pressure)